



# Articulate Robot Controller - RCA620

User Manual

Original Instruction





## Semiconductor Subsystem

- Semiconductor/LED/Panel
- EFEM (Equipment Front End Module)
  - Wafer Robot
  - Load Port
  - Wafer Aligner



## Multi-Axis Robot

- Pick-and-Place / Assembly / Array and Packaging / Semiconductor / Electro-Optical Industry / Automotive Industry / Food Industry
- Articulated Robot
  - SCARA Robot
  - Electric Gripper
  - Integrated Electric Gripper



## Single-Axis Robot

- Precision / Semiconductor / Medical / FPD
- KK, SK
  - KS, KA
  - KU, KE, KC



## Torque Motor Rotary Table

- Medical / Automotive Industry / Machine Tools / Machinery Industry
- RAB Series
  - RAS Series
  - RCV Series
  - RCH Series



## Ball screw

- Precision Ground / Rolled
- Super S Series
  - Super T Series
  - Mini Roller
  - Ecological & Economical Lubrication Module E2
  - Rotating Nut (R1)
  - Energy-Saving & Thermal-Controlling (Cool Type)
  - Heavy Load Series (RD)
  - Ball Spline



## Linear Guideway

- Automation / Semiconductor / Medical
- Ball Type--HG, EG, WE, MG, CG
  - Quiet Type--QH, QE, QW, QR
  - Other--RG, E2, PG, SE, RC



## Bearing

- Machine Tools / Robot
- Crossed Roller Bearing
  - Ballscrew Bearing
  - Support Unit



## DATORKER® Strain Wave Gear

- Robot / Automation Equipment / Semiconductor Equipment / Machine Tools
- DSC Type
  - DSH Type
  - DGC Type
  - DGH Type
  - DLC Type



## AC Servo Motor & Drive

- Semiconductor / Packaging Machine / SMT / Food Industry / LCD
- Drives--D1, D2T/D2T-LM, E1
  - Motors--FR, E1



## Medical Equipment

- Hospital / Rehabilitation Centers / Nursing Homes
- Robotic Gait Training System
  - Robotic Endoscope Holder



## Linear Motor Stage

- Automated Transport / AOI Application / Precision / Semiconductor
- Iron-core Linear Motor
  - Coreless Linear Motor
  - Linear Turbo Motor LMT
  - Planar Servo Motor
  - Air Bearing Platform
  - X-Y Stage • Gantry Systems
  - Single-Axis Linear Motor Stage



## Torque Motor & Direct Drive Motor

- Machine Tools
- Torque Motor--TM-2/IM-2, TMRW Series
- Inspection / Testing Equipment / Robot
- Direct Drive Motor--DMS, DMY, DMN, DMT Series

## Warranty Terms and Conditions

The period of warranty shall commence at the received date of HIWIN product (hereafter called “product”) and shall cover a period of 12 months. The warranty does not cover any of the damage and failure resulting from:

- The damage caused by using with the production line or the peripheral equipment not constructed by HIWIN.
- Operating method, environment and storage specifications not specifically recommended in the product manual.
- The damage caused by changing installation place, changing working environment, or improper transfer after being installed by the professional installer.
- Product or peripheral equipment damaged due to collision or accident caused by improper operation or installation by the unauthorized staff.
- Installing non-genuine HIWIN products.

The following conditions are not covered by the warranty:

- Product serial number or date of manufacture (month and year) cannot be verified.
- Using non-genuine HIWIN products.
- Adding or removing any components into/out the product without authorized.
- Any modification of the wiring and the cable of the product.
- Any modification of the appearance of the product; removal of the components inside the product. e.g., remove the outer cover, product drilling or cutting.
- Damage caused by any natural disaster. i.e., fire, earthquake, tsunami, lightning, windstorms and floods, tornado, typhoon, hurricane etc.

HIWIN does not provide any warranty or compensation to all the damage caused by above-mentioned circumstances unless the user can prove that the product is defective.

For more information towards warranty terms and conditions, please contact the technical staff or the dealer who you purchased with.



## WARNING

- ❖ Improper modification or disassemble the robot might reduce the robot function, stability or lifespan.
- ❖ The end-effector or the cable for devices should be installed and designed by a professional staff to avoid damaging the robot and robot malfunction.
- ❖ Please contact the technical staff for special modification coming from production line set up.
- ❖ For the safety reason, any modification for HIWIN product is strictly prohibited.

## Safety Precautions



### 1. Safety Information

- Safety Responsibility and Effect
  - ⊙ This chapter explains how to use the robot safely. Be sure to read this chapter carefully before using the robot.
  - ⊙ The user of the HIWIN industrial robot has responsibility to design and install the safety device meeting the industrial safety regulations in order to ensure personal safety.
  - ⊙ In compliance with the safety information on industrial robot described in this manual can't guarantee that *HIWIN* robot will not occur any safety problems.
  - ⊙ This machine is defined as a partly completed machinery, the associated hazards must be handled by system integrator in accordance with ISO 102018-1/-2.
  - ⊙ A safety-related part of control system (SRP/CS) should conform to the requirement of performance level d and category 3 according to ISO 13849-1.
  - ⊙ The installation for emergency functions shall be defined by the system integrator in accordance with ISO 10218-1/2.
  
- Safety Operation Principle
  - ⊙ Before connecting the power supply for HIWIN industrial robot startup assembly procedure, check whether the specification of factory output voltage matches the specification of input voltage of the product. If it does not match, ensure to use the corresponding transformer (HIWIN optional transformer is recommended).
  - ⊙ Emergency Stop button (on Teach Pendant or from external emergency stop switch) must be pressed before turning off the power, and then switch off the power switch.
  - ⊙ While connecting to the external I/O or the signal, please operate in the condition that the power switch is turned off to prevent from a shortcut caused by mistaken touch in the process, and resulting in damage.

## 2. Description Related to Safety

### I. Safety Symbols

- ⦿ Carefully read the instructions in the user manual prior to robot use. The following shows the safety symbols used in this user manual.

Symbol	Description
 <b>DANGER</b>	Failure to follow instructions with this symbol may result in serious hazard or personal injury. Please be sure to comply with these instructions.
 <b>WARNING</b>	Failure to follow instructions with this symbol may result in personal injury or product damage. Please be sure to comply with these instructions.
 <b>CAUTION</b>	Failure to follow instructions with this symbol may result in poor product performance. Please be sure to comply with these instructions.

### II. Working Person

- ⦿ The personnel can be classified as follows
  - Operator:
    - Turns robot controller ON/OFF
    - Starts robot program from operator's panel
    - Reset system alarm
  - Programmer or teaching operator:
    - Turns robot controller ON/OFF
    - Starts robot program from operator's panel
    - Reset system alarm
    - Teaches robot
  - Maintenance engineer:
    - Turns robot controller ON/OFF
    - Starts robot program from operator's panel
    - Reset system alarm
    - Teaches robot
    - Does maintenance, adjustment, replacement
- ⦿ Programmer and the maintenance engineer must be trained for proper robot operation.

### 3. Precautions

#### 3.1 Common Safety Issues

 <b>DANGER</b>	<ul style="list-style-type: none"> <li>❖ All operating procedures should be assessed by professional and in compliance with related industrial safety regulations.</li> <li>❖ When operating robot, operator needs to wear safety equipment, such as workwear for working environment, safety shoes and helmets.</li> <li>❖ When encountering danger or other emergency or abnormal situation, please press the emergency stop button immediately. After danger is eliminated, move the robot away with low speed in manual mode.</li> <li>❖ When considering safety of the robot, the robot and the system must be considered at the same time. Be sure to install safety fence or other safety equipment and the operator must stand outside the safety fence while operating the robot.</li> <li>❖ A safety zone should be established around the robot with an appropriate safety device to stop the unauthorized personnel from access.</li> <li>❖ While installing or removing mechanical components, be aware of a falling piece which may cause injury to operator.</li> <li>❖ Ensure the weight of workpiece does not exceed the rated load or allowable load moment at wrist. Exceeding these values could lead to the driver alarm or malfunction of the robot.</li> <li>❖ Do not climb on manipulator.</li> <li>❖ Do not store the machine in the environment with corrosion and flammable gas or close to the flammable object.</li> <li>❖ Do not operate the machine in the environment with moisture, water or grease.</li> <li>❖ Do not operate the machine at the place where vibration or the strong impact occurs.</li> </ul>
---	--

	<ul style="list-style-type: none"> <li>❖ Do not immerse the electric wires into grease or water.</li> <li>❖ Do not connect or operate the machine with wet hands.</li> <li>❖ Do not operate the machine in potentially explosive environment.</li> <li>❖ Please ensure the controller is grounded.</li> <li>❖ Keep hands away from the inner part of the controller while it is connecting to the power or during operating.</li> <li>❖ Do not touch the heat sink, regenerative resistance, the power supply or the computer inside the controller while it is operating due to its high temperature.</li> <li>❖ Be sure power is disconnected prior to repair and maintenance, and ensure to operate under the condition of no electrical shock risk.</li> <li>❖ Do not disassembly the controller without permission. If there's any issues, please contact our engineers.</li> </ul>
<p> <b>WARNING</b></p>	<ul style="list-style-type: none"> <li>❖ The personnel installing robot should be trained and licensed.</li> <li>❖ To ensure personal safety, robot installation must comply with this manual and related industrial safety regulations.</li> <li>❖ The control cabinet should not be placed near high voltage or machines that generate electromagnetic fields to prevent interference that could cause the robot to deviation or malfunction.</li> <li>❖ Using non-HIWIN spare parts to repair may cause robot damage or malfunction.</li> <li>❖ Beware of the heat generated by the controller and servo motor.</li> <li>❖ Do not overbend the cable to avoid poor circuit contact or unexpected damage.</li> <li>❖ Do not stand on the controller or put heavy objects on it.</li> </ul>



	<ul style="list-style-type: none"><li>❖ Do not block the vent or put foreign objects into the controller.</li><li>❖ Please ensure the controller is fixed on the base.</li><li>❖ Do not pull the connector violently or twist the electric wires excessively.</li><li>❖ Do not frequently switch ON/OFF the power switch and the control button.</li><li>❖ Please ensure that the robot, the emergency stop switch and the controller are functioning properly before performing any work.</li><li>❖ Do not shutdown the power switch during the operation.</li><li>❖ Do not open, modify, disassemble and maintain the machine without permission.</li><li>❖ The power must be disconnected when the machine does not operate in a long time.</li><li>❖ Do not turn off the power of the controller when modifying the program or parameter. Otherwise, the data stored in the controller will be damaged.</li><li>❖ After the brake of a servo motor is released, the robot will be moved due to gravity and it may injured the operator.</li><li>❖ The industrial robots can be applied for the different industrial environments.</li><li>❖ When the operating procedures are interrupted, the special attention should be paid during the troubleshooting.</li></ul>
--	---

### 3.2 Operation

 <p><b>DANGER</b></p>	<ul style="list-style-type: none"> <li>❖ Teaching, jogging or programming should be done outside of the safety fence. If it is inevitable to enter the safety fence, press the emergency stop button before entrance. Operation should be restricted at low speed and beware of surrounding safety.</li> <li>❖ All operations shall be executed by trained staff.</li> </ul>
--	--



### 3.3 Maintenance

 <p><b>DANGER</b></p>	<ul style="list-style-type: none"> <li>❖ Please contact us if the procedure not specified by HIWIN is needed.</li> <li>❖ Please contact us if the replacement of the component not specified by HIWIN is needed.</li> <li>❖ Be sure to carry out regular maintenance, otherwise it will affect the service life of the robot or other unexpected danger.</li> <li>❖ Prior to repair and maintenance, please switch off power supply.</li> <li>❖ Maintenance and repair should be performed by a qualified operator with a complete understanding of the entire system to avoid risk of robot damage and personal injury.</li> <li>❖ When replacing the components, avoid foreign object going into the robot.</li> </ul>
--	--



### 3.4 End Effector

The end effector can be classified as two types:

- A. Gripper: Used to load and unload, such as pneumatic gripper, electric gripper and vacuum sucker.
- B. Tool: Used to process, such as welding, cutting and surface treatment.



 <p><b>DANGER</b></p>	<ul style="list-style-type: none"> <li>❖ More attention must be paid to the design of the end effector to prevent power loss or any other errors that could lead to workpiece falling or damage.</li> <li>❖ The tool-type end effector is usually equipped with high voltage, high temperature and active rotary shaft. Special attention should be paid to the operating safety.</li> <li>❖ The end effector should be mounted firmly on the robot to avoid workpiece fall during operation which may cause personal injury or hazard.</li> </ul>
 <p><b>WARNING</b></p>	<ul style="list-style-type: none"> <li>❖ The end effector may be equipped with its own control unit. During installation, pay attention to installed location. Ensure that the control unit does not interfere with robot operation.</li> <li>❖ The gripper-type end effector should prevent the workpiece from dropping or damaging when the robot experiences a power error or other errors. If potential dangers or abnormal situations exist when using end effector, the associated hazards must be handled by the system integrator in accordance with the related standards.0</li> </ul>

### 3.5 Pneumatic, Hydraulic System

 <p><b>DANGER</b></p>	<ul style="list-style-type: none"> <li>❖ When using the pneumatic or hydraulic system, the gripped workpiece may fall due to insufficient pressure or gravity.</li> <li>❖ The pneumatic or hydraulic system must be equipped with the relief valve, so that it can be applied in an emergency.</li> </ul>
 <p><b>WARNING</b></p>	<ul style="list-style-type: none"> <li>❖ More attention should be paid to the pressure remained in the pneumatic systems after the power is disconnected.</li> </ul>

	<ul style="list-style-type: none"> <li>❖ The internal pressure must be released before the pneumatic systems are maintained.</li> <li>❖ More attention should be paid to the pressure in the pneumatic system as it is several times more than the atmosphere pressure.</li> </ul>
--	--

### 3.6 Emergency Stop Switch

 <b>DANGER</b>	<ul style="list-style-type: none"> <li>❖ The robot or other control component should have at least one device for immediate halt, such as an emergency stop switch.</li> <li>❖ The emergency stop button must be installed in an easily accessible location for quick stop.</li> <li>❖ While executing an emergency stop, power to the servo motor will be cut, and all movements will be stopped. And the control system will be shut down. Emergency stop should be reset if the restoration of operating procedure is wanted.</li> <li>❖ Avoid using emergency stop to replace a normal stop procedure. This could reduce the lifespan of the robot.</li> </ul>
 <b>WARNING</b>	<ul style="list-style-type: none"> <li>❖ The drive power and the control system will be disconnected to stop all actions during the emergency stop.</li> <li>❖ If you want to restart the procedures, you should reset the emergency stop switch.</li> <li>❖ Emergency stop established an immediate stop: Immediately stop the robot system, and disconnect the driver power.</li> <li>❖ The emergency stop switch is used for emergency stop only.</li> <li>❖ The <i>HIWIN</i> robot is equipped with two emergency stop switches, where one is installed on the teach pendant and the other is directly connected to the controller via a cable. If additional emergency stop switches are required, other connecting method can be applied for the same purpose.</li> <li>❖ Based on the relevant industrial safety regulations, the emergency stop switch is directly connected to</li> </ul>

	<p>the controller of the robot via the physical wires.</p> <ul style="list-style-type: none"><li>❖ If the version of the braking is not applied to the whole axis, once the emergency stop is executed and the heavy objects are loaded on the robot end, the axis without brake will move due to gravity. This attention must be paid for safety issue.</li></ul>
--	--

#### 4. Intended use

HIWIN robots are industrial robots and intended for pick-and-place, handling, assembling, deburring, grinding and polishing. Use is only permitted under the specified environment, for more detailed information please see section 2.5 environmental conditions.

Use is not permitted under the following conditions:

- Use in potentially explosive environments
- Use without performing risk assessments
- Transportation of people and animals
- Operation outside the allowed operating parameters

#### 5. Disposal

The disposal of HIWIN robot shall be in accordance with the local environmental regulations.

## Content

1. Specifications.....	13
1.1 Standard Specification .....	13
1.2 Description of Model Name.....	14
1.3 Standard and Optional Equipment.....	15
1.4 Appearance Dimensions.....	16
1.5 Recommended installation method.....	17
1.6 Operating Environment.....	18
1.7 Sticker and Label .....	19
2. Installation.....	21
2.1 The function of each component outside the controller.....	21
2.2 Power Connection.....	22
2.3 Instruction of Controller ON/OFF Procedure .....	24
2.4 Controller Boot/Shutdown Program Description.....	25
2.5 Motor Cable Connection (CN2).....	29
2.6 Emergency Stop Switch Connection (CN3) .....	30
3. External Input/ Output .....	32
3.1 Function I/O .....	32
3.2 Digital I/O .....	34
3.3 Digital I/O Expansion Module (Optional).....	37
3.4 Network Connection Port .....	40
4. Teach Pendant .....	42
5. Maintenance.....	44
5.1 UPS Battery (Only For Non-CE Version).....	44

Version	Date	Applicable Scope	Note
1.0.0	Jan. 5, 2018	RCA620	First edition
2.0.0	Aug. 31,2018	RCA620	1. Added transformer and other cable connector. 2. Added fuse accessory kit.
2.0.1	Sept. 18,2018	RCA620	1. Modified UPS battery maintenance chapter

# 1. Specifications

## 1.1 Standard Specification

The following table shows the standard specifications of the robot controller.

Item		HIWIN Robot Controller
Model No.		RCA620
Positioning control		PTP(point-to-point) CP(continuous path)
Joint control		AC servo control
Operating system		HRSS
Memory capacity	Fixed point	5000
	Step number	10000
Teaching method		Teach pendant
Communication interface	Ethernet	1
	USB	1
External I/O	Emergency stop input	Input : 1
	Function I/O	Input : 8 Output : 8
	Digital I/O	Input : 16 Output : 16
Power	Input power range (VAC)	Three-phase 200-240
	Power capacity (KVA)	3.5
	Power frequency (Hz)	50/60
	Voltage drop (msec)	10 or less
	Rating output current (A)	22
Weight (kg)		80
Protection rating		IP54
Temperature range for workplaces (°C)		0-40
Relative humidity (%RH)		45-80
Grounding		Below100Ω

## 1.2 Description of Model Name

### Model

Model example

**RCA620 – 1621**

	1621	Maximum Reach Radius
		1621 mm
		1739 mm
RCA620	Series	
	RCA620 Series articulated robot controller	



### 1.3 Standard and Optional Equipment

Standard and optional equipment for 620 series robot controller.

Item	HIWIN Part No.	Standard	Optional	Remark
CN2, Power Signal Cable 5M	AH300T01	●	○	Refer to CH 2.5
Controller Door Key	N/A	●	○	Attached to controller
Teach Pendant	AH300U01	●	○	Refer to CH 4
CN3 Emergency Stop Switch Unit 5M	4C7006F1		○	Refer to CH 2.6
Connector Accessory Kit	4C201GN1	●	○	Refer to table 1
Fuse Accessory Kit	4C2024Q1	●	○	Refer to table 2
Functional I/O Module	4C201GM1		○	Refer to CH.3.1
Digital I/O Module	4C201GP1		○	Refer to CH 3.2
External I/O Extension Module (Include expansion card and wiring set) (Note 1)	4C201GQ1		○	Refer to CH 3.3
UPS battery (For Non-CE version)	462C0097		○	Refer to CH 5.1
Transformer Power Cable	4C704YW1		○	Refer to CH 2.2
2KVA Transformer	462D0046		○	Refer to CH 2.2
2KVA Transformer, Box, UL version(Note 2)	462D004B		○	Refer to CH 2.2

\*Note 1: Maximum Expansion - 16 Input and 16 Output (Optional)

\*Note 2: The above transformers are all I/P380V-415V-480V-575V, O/P220V

Table 1: Connector accessory kit item content:

Item	HIWIN Part No.	Quantity
D-Sub Connector 15P	461800VZ	1
D-Sub Connector 26P	461800W1	1
D-Sub Connector 25P	461800W0	2
D-Sub Connector Dust Cover 15P, 26P	461800VW	2
D-Sub Connector Dust Cover 25P	461800VX	2

Table 2: Fuse accessory kit item content:

Item	HIWIN Part No.	Quantity
Fuse 2A	4611009N	1
Fuse 5A	4621004D	1
Fuse 1.5A	46210041	1
Fuse 20A	4621004Z	3.

## 1.4 Appearance Dimensions

The following show the appearance dimensions of the robot controller (unit: mm).

### Front view

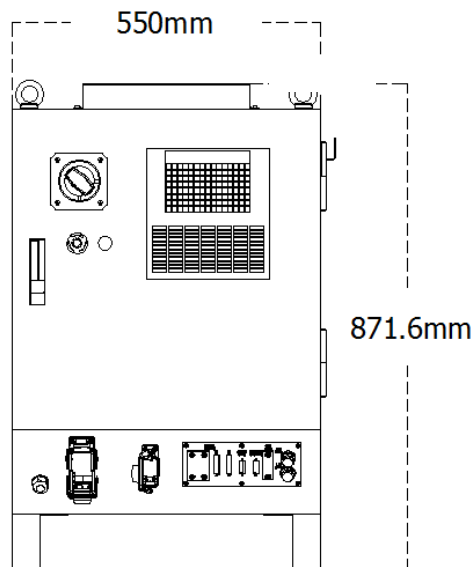

### Side view

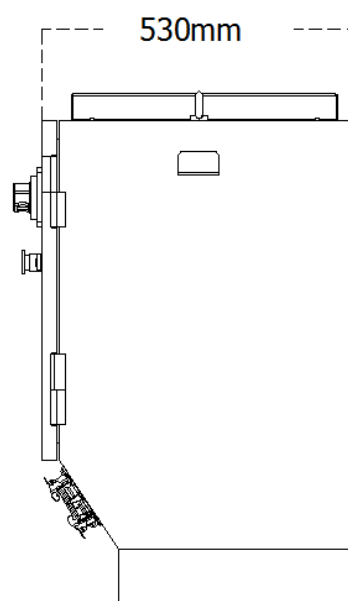

## 1.5 Recommended installation method

Controller should be placed upright (as shown in the following figure). Please keep 800mm clearance from the front door for opening the front door and cable installation.

Unit: mm

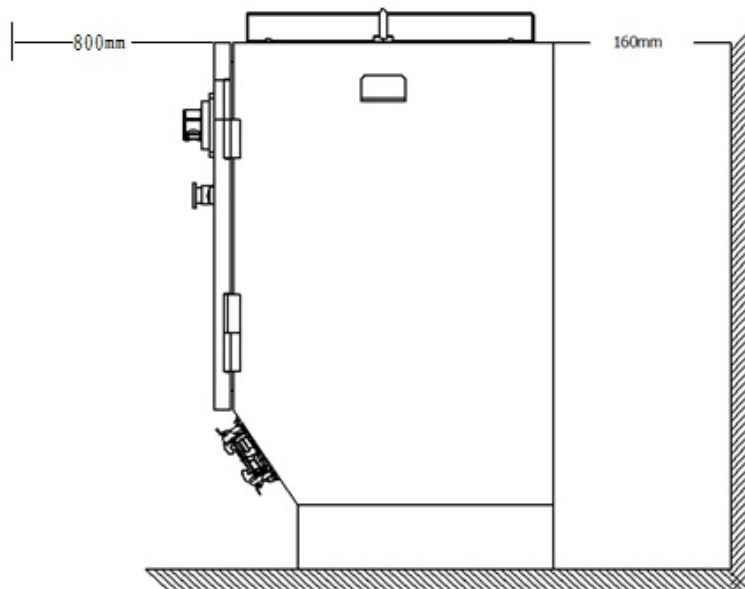
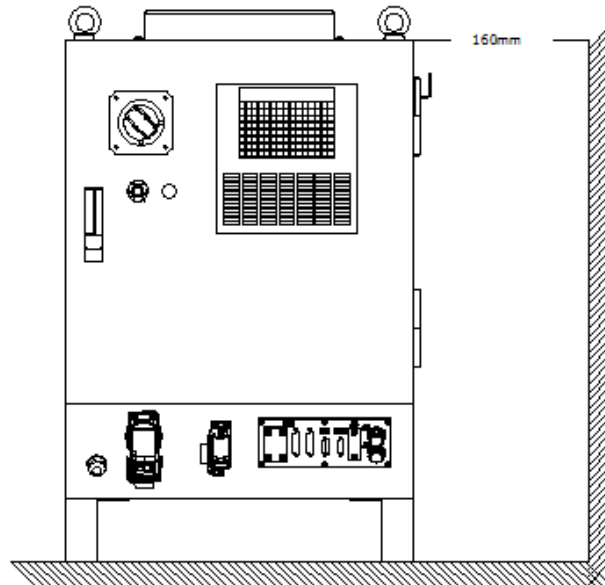

**CAUTION**

- ❖ Controller should be placed upright as in above figure. It is forbidden to install the controller 90 degree or 180 degree from the upright posture.

## 1.6 Operating Environment

The robot controller employs the IEC protection rating as IP54.



 <p><b>WARNING</b></p>	<ul style="list-style-type: none"><li>❖ The controller should not be placed at the environment with moisture, with high temperature, under direct sunlight or potentially explosive environment.</li><li>❖ Please keep the controller away from the strong electric field or the magnetic field.</li><li>❖ Please place the controller at flat place, and avoid shaking.</li><li>❖ Filter for heat exchanger needs to be cleaned regularly.</li><li>❖ When installation, please reserve at least 160mm space from the wall for dissipating heat.</li><li>❖ Please make sure the controller is fixed stably by the screws.</li></ul>
--	---

### 1.7 Sticker and Label

The following shows the appearance stickers and labels on the robot controller.

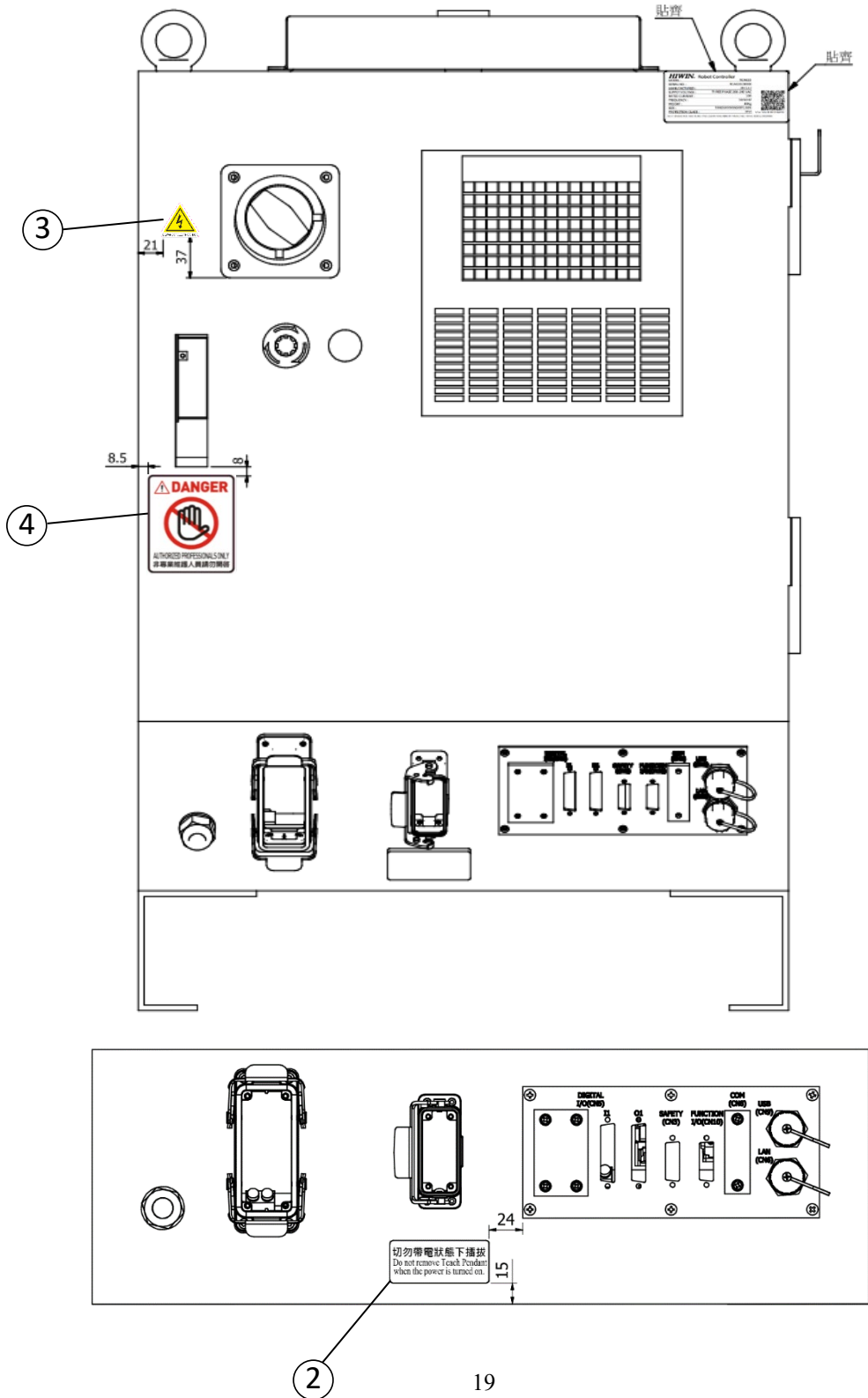
Front view

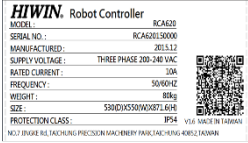

No.	Illustration	Description
1	 <p> <b>HIWIN</b> Robot Controller            MODEL: RCAG20            SERIAL NO.: RCAG015000            MANUFACTURED: 2015.12            SUPPLY VOLTAGE: THREE PHASE 200-240 VAC            RATED CURRENT: 20A            FREQUENCY: 50/60HZ            WEIGHT: 88kg            SIZE: 580(D)X550(W)X271(H)mm            PROTECTION CLASS: IP54  <small>YIFA MADE IN TAIWAN</small>  <small>HIWIN IS A REGISTERED TRADEMARK OF HIWIN TECHNOLOGY CO., LTD.</small> </p>	Controller specification
2	<p>切勿帶電狀態下插拔 Do not remove Teach Pendant when the power is turned on.</p>	Do not remove Teach Pendant when the power is turned on
3	 <p>BEWARE OF ELECTRIC SHOCK</p>	Beware of electric shock
4	 <p> <b>DANGER</b>            AUTHORIZED PROFESSIONALS ONLY            非專業維護人員請勿開啓         </p>	Danger: authorized professionals only

## 2. Installation

### 2.1 The function of each component outside the controller

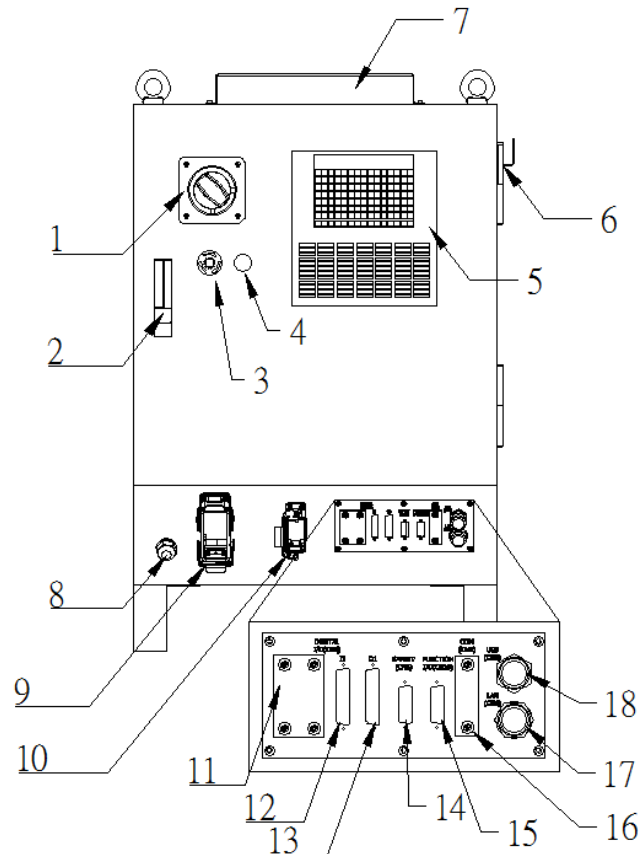

No.	Item	No.	Item
1	Power Switch	11	Reserved for I/O expansion
2	Door Lock	12	CN5 I1
3	Emergency stop button	13	CN5 O1
4	Power indicator	14	Emergency Stop Connector(CN3)
5	Heat exchanger	15	Function I/O connector (CN10)
6	Teach pendant hanger	16	Reserved for expansion
7	Cover for regenerative resistor	17	Network Connector
8	Main Power Source	18	USB Connector
9	Motor Connector(CN2)		
10	Teach Pendant Connector(CN4)		

## 2.2 Power Connection

The picture below is an example of power connection structure. This controller needs to be supplied with three-phase AC200-240V, and the ground connection should be separated from main power breaker.

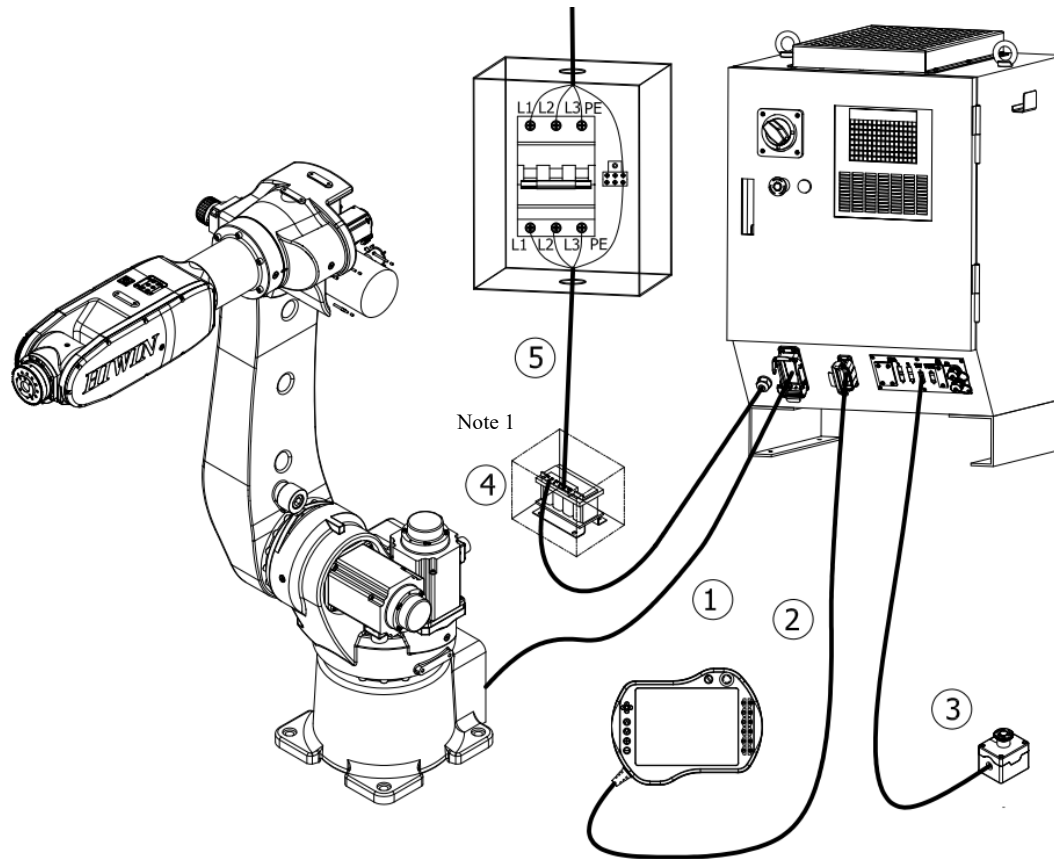



No.	RCA620 series basic connection structure
1	CN2 Power & Signal Cable
2	CN4 Teach Pendant
3	CN3 Emergency Stop Switch
4	Transformer <sub>(Note 1)</sub>
5	Transformer power cable <sub>(Note 1)</sub>

\*Note 1: RCD403 series robot arm controller input voltage specification is three-phase 220V. If the power supply specifications of the client are different, the transformer must be connected in series.

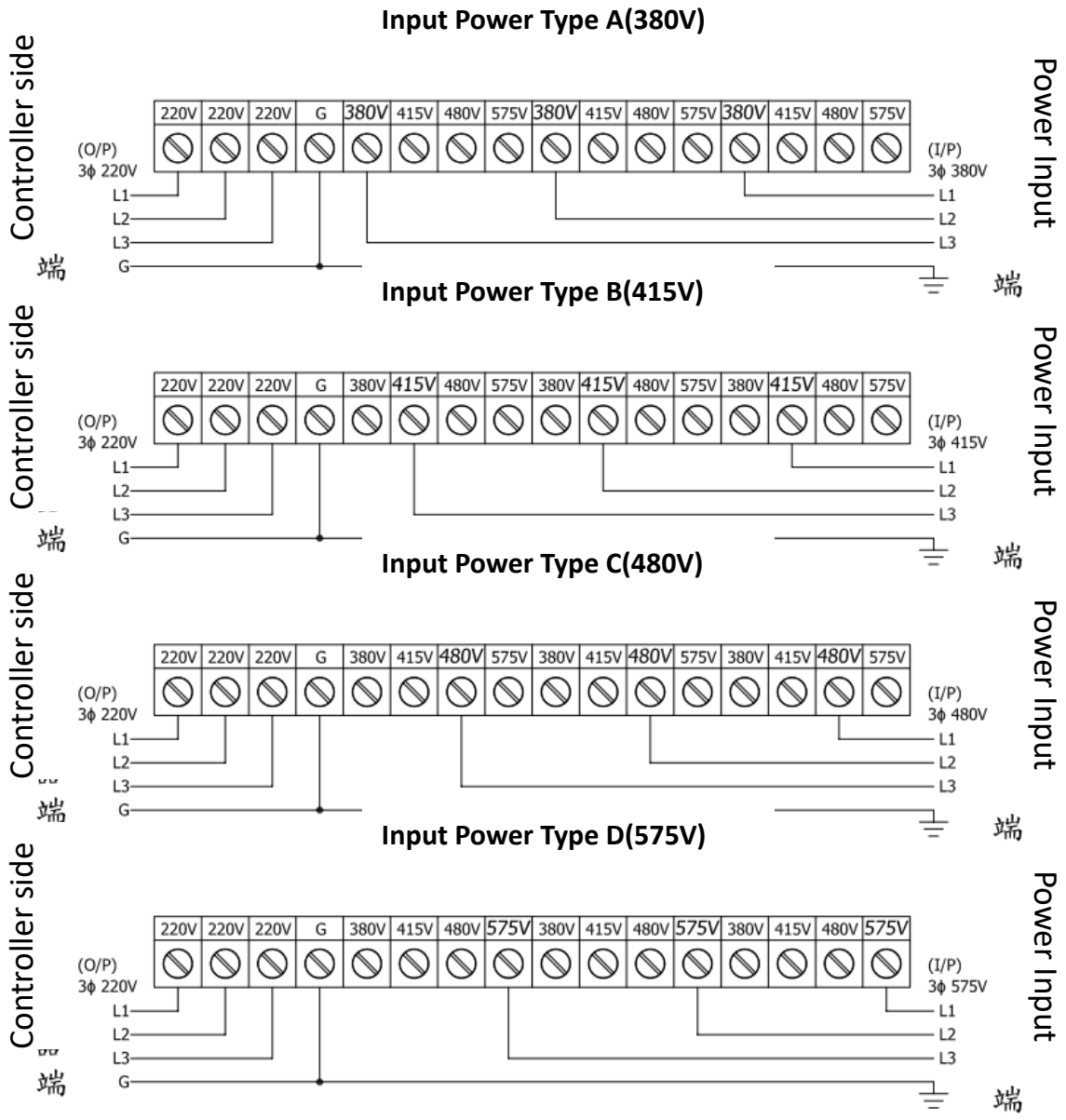



## 2.3 Instruction of Controller ON/OFF Procedure

No.	Item	Illustration	Description
1	Power Switch		<p>Controller ON: After the power is connected, turn the power switch to state "I-ON". The power indicator will turn ON.</p> <p>Controller OFF: (1) Operate the robot to a safe posture, and then stop the motion. (2) Press the emergency stop button. (3) Turn the power switch on the controller panel to state "O-OFF". (4) After controller shutting down, power indicator will turn OFF.</p>
2	Power Indicator		<p>When robot controller is ON, this indicator will turn ON. When robot controller is OFF, this indicator will turn OFF.</p>

 <b>WARNING</b>	<ul style="list-style-type: none"> <li>❖ If you want to stop a moving robot, you should go through the normal procedure and press the stop button instead of the emergency stop.</li> <li>❖ Please stop the robot and press the emergency stop button before turning it off. Directly cut off the power while robot is moving may cause an unexpected danger.</li> </ul>
---	--

## 2.4 Controller Boot/Shutdown Program Description

Boot – Power on by flipping up the power switch.

Shutdown – HIWIN industrial robot (HRSS version 3.2.12 above, if having previous version, it is highly recommended to update the newest version) provided with 2 types of shutdown program. “Software shutdown” and “Digital input control shutdown” respectively, choose either one to execute:

### 1. Using software to shutdown -

Procedure for shutting down are as follows:

- (1) Stop the motion of the robot manipulator.
- (2) Press the emergency stop button.
- (3) Press the software shutdown button.

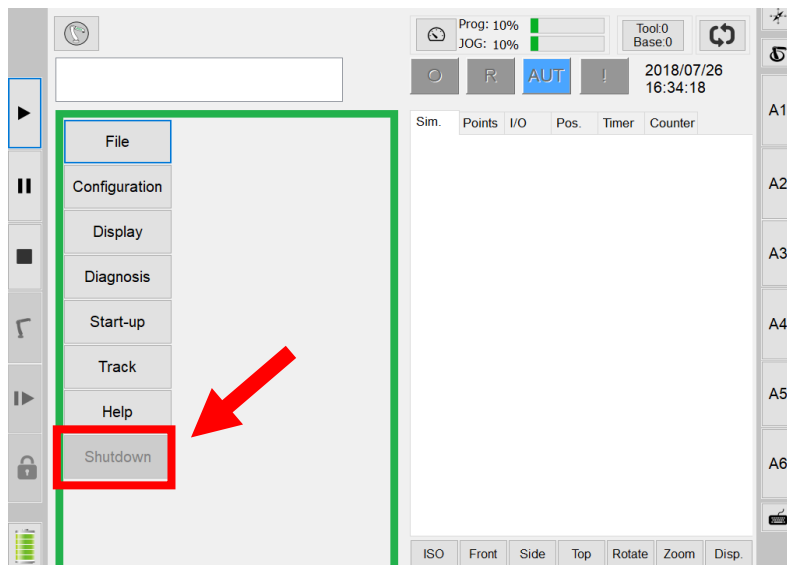

- (4) Wait at least 5 seconds before switching off the power. (Switch off the controller switch or cut off the main power directly)

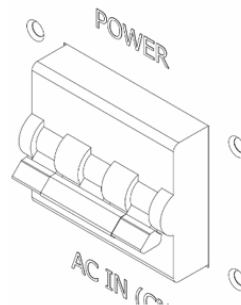

 <b>CAUTION</b>	<p>❖ Operator must not leave until the power switch is switched off.</p>
---	--

2. Using digital input (DI) to control shutdown –  
Please set the option of DI/DO in the HRSS software program.  
The setting method is as follows:

Step 1:

Enter HRSS function page, click Start-up -> System Setting -> DIO Setting

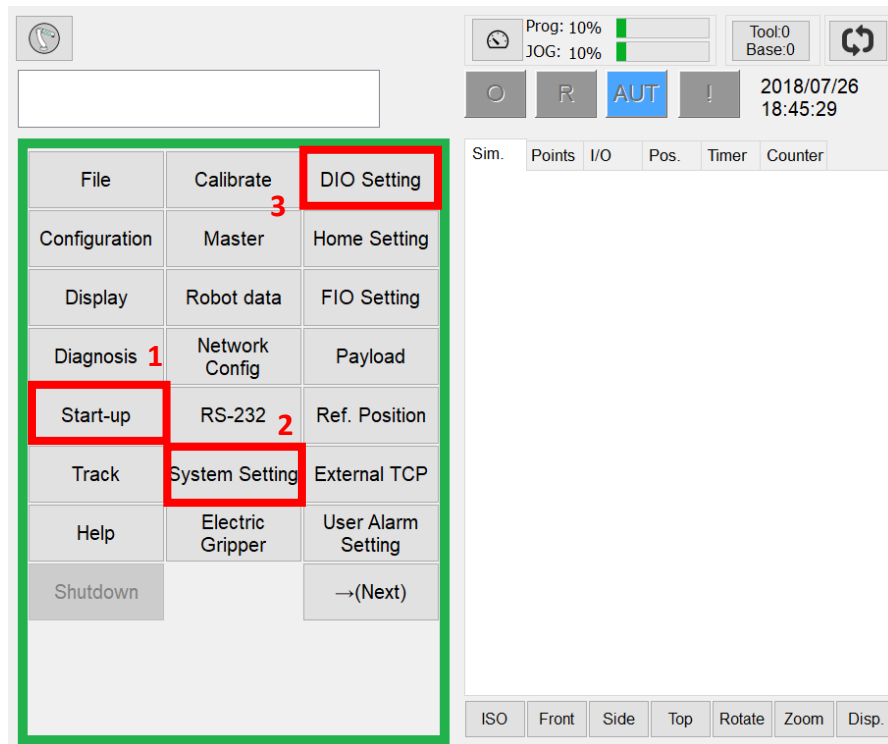

Step 2:

**DI setting**

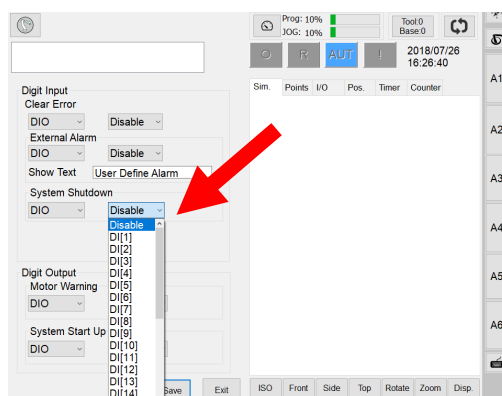

Please select the DI pin to be set by the customer.

**DO Setting**

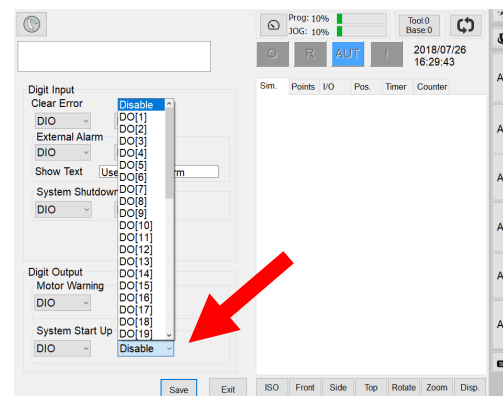

Please select the DO pin to be set by the customer.

Step 3:

Please press SAVE after setting.

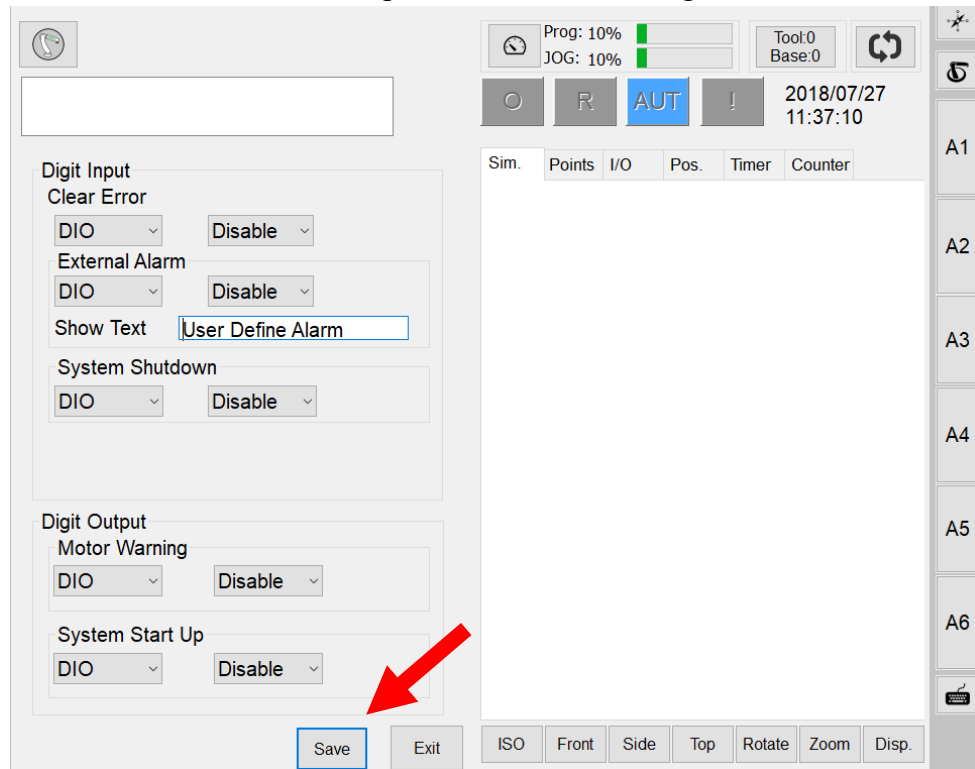



Procedure for shutting down are as follows:

- (1) Stop the motion of the robot manipulator.
- (2) Press the emergency stop button.
- (3) Two types of method: (select either one to execute)
  - a. After connecting digital input (DI) to trigger shutdown, wait at least 5 seconds before switching off the power. (Switch off the controller switch or cut off the main power directly)
  - b. After connecting digital input (DI) to trigger shutdown, the controller should receive the digital output (DO) feedback to switch off the power. (Automatically generated by the system without additional control) (Switch off the controller switch or cut off the main power directly)

 <b>CAUTION</b>	<p>❖ Operator must not leave until the power switch is switched off.</p>
---	--

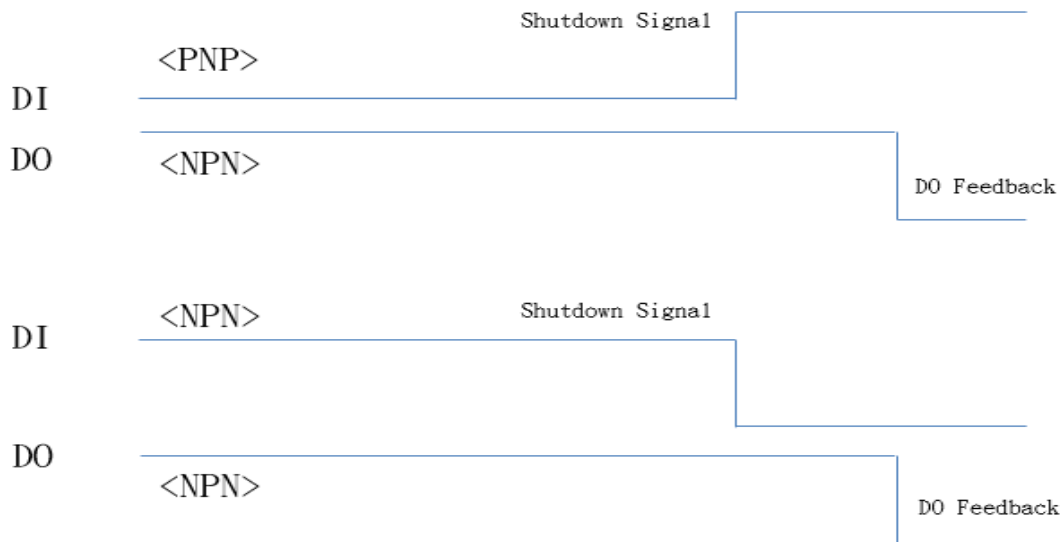
### Digital Input Shutdown Timing:



 <b>WARNING</b>	<ul style="list-style-type: none"> <li>❖ If the above procedure is not completed, please do not directly switch off the power switch on the controller or cut off the main power. Improper shutdown could cause damage to the controller.</li> <li>❖ Please wait for 30 seconds to reboot. Do not reboot immediately after switching off the power switch.</li> <li>❖ If stopping a robot in motion is required, please avoid using emergency button. To stop the program, press the stop button.</li> <li>❖ Please stop the motion of the manipulator before shutting down. Then perform the shutdown procedure to avoid unexpected danger when the power is cut off during the motion.</li> </ul>
---	---

## 2.5 Motor Cable Connection (CN2)

### Description:

The motor cable connects the robot and the controller with a 5m cable.

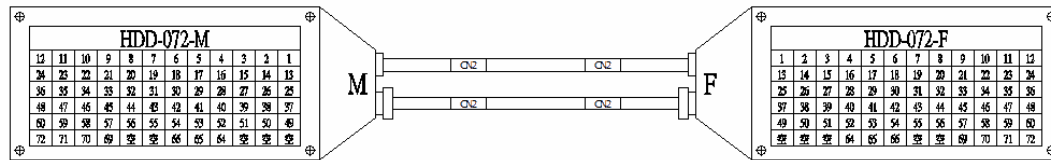

### Connection method:

<p>The motor connection port on the controller is CN2 connector which is designed mistake-proofing. If it cannot be plugged in, please flip and connect it again.</p>	
<p>Plug the motor cable into CN2 connector, and buckle up the safety lock indeed.</p>	

 <b>WARNING</b>	<ul style="list-style-type: none"> <li>❖ Plug the connector in the direction parallel to the pins to avoid the internal pins being crooked and deformed.</li> <li>❖ According to different operating condition, the temperature of the cable would rise slightly. Remove plastic cover before connection.</li> <li>❖ Please avoid severe impact while installation.</li> </ul>
--------------------	--

## 2.6 Emergency Stop Switch Connection (CN3)

### Description:

Connector CN3 is a female DSUB-15 connector for emergency stop.

Emergency stop switch (optional equipment) is a button box with a 5m wire. It should be placed at the position, which is convenience to reach. DSUB-15 soldering connector is included in the connector kit.



### Emergency stop switch wiring diagram



CN3

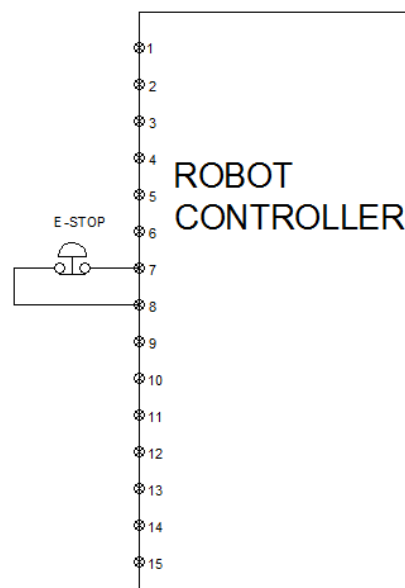





### CAUTION

- ❖ Please ensure that the emergency stop switch and the emergency stop on the teach pendant are secured before operates the robot.
- ❖ When using emergency stop connector, please make sure the connection is secure,
- ❖ Maximum contact current is 6A.
- ❖ Be sure to use D-SUB 15P connector to connect to CN3 connector. Do not wire without proper connector.



**Connection Method:**

<p>The connector of emergency stop device on controller is CN3 which is designed fool-proofing. If it cannot be plugged in, please flip and connect it again. Please remove protection cover before connection.</p>	
<p>Plug the connector into CN3 and secure the screws indeed.</p>	
<p>Be sure to release the emergency stop switch before moving the robot.</p>	

 <b>DANGER</b>	<p>❖ The emergency stop device must be connected with the controller and be placed at the position accessible to operator. Wrong way of using can cause a severe damage or loss of life and property.</p>
--	---

 <b>CAUTION</b>	<p>❖ Before operates the robot, check if emergency stop switch and emergency stop switch on the teach pendant are in reset states.</p>
---	--

### 3. External Input/ Output

There are two types of controller external I/O:

- (1) Function I/O (FI/O) → specific function I/O
- (2) Digital I/O (DI/O) → external I/O for customer's configuration

#### 3.1 Function I/O

**Description:**

1. Standard equipment has function I/O of 8IN/8OUT, which are in the CN10 (D-SUB 26P) connector.
2. Connection cable for function I/O is an optional equipment (as shown on the picture on the right side)

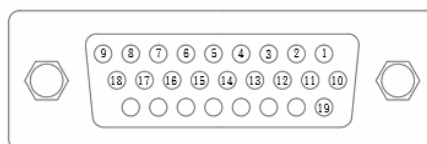

CN10

#### Function I/O List

INPUT			OUTPUT		
Pin	Parameter	Function	Pin	Parameter	Function
1	START	Execute program	10	RUN	Program running
2	HOLD	Pause program	11	HELD	Program pausing
3	STOP	Stop program	12	FAULT	Controller failure
4	ENBL	Enable Function I/O	13	READY	Controller ready
5	RSR1/PNS1	Robot service request 1/ program selection 1	14	ACK1/SNO1	RSR 1 feedback signal / selection program No. 1
6	RSR2/PNS2	Robot service request 2/ program selection 2	15	ACK2/SNO2	RSR 2 feedback signal / selection program No. 2
7	RSR3/PNS3	Robot service request 3/ program selection 3	16	ACK3/SNO3	RSR 3 feedback signal / selection program No. 3
8	RSR4/PNS4	Robot service request 4/ program selection 4	17	ACK4/SNO4	RSR 4 feedback signal / selection program No. 4
9	FICOM1	common terminal	18	FOPWR1	External power input 24V
			19	FOGND1	External power input 0V

**Function I/O (CN10) wiring diagram**

 : External power supply

Input: NPN  
Output: NPN

Input: PNP  
Output: NPN

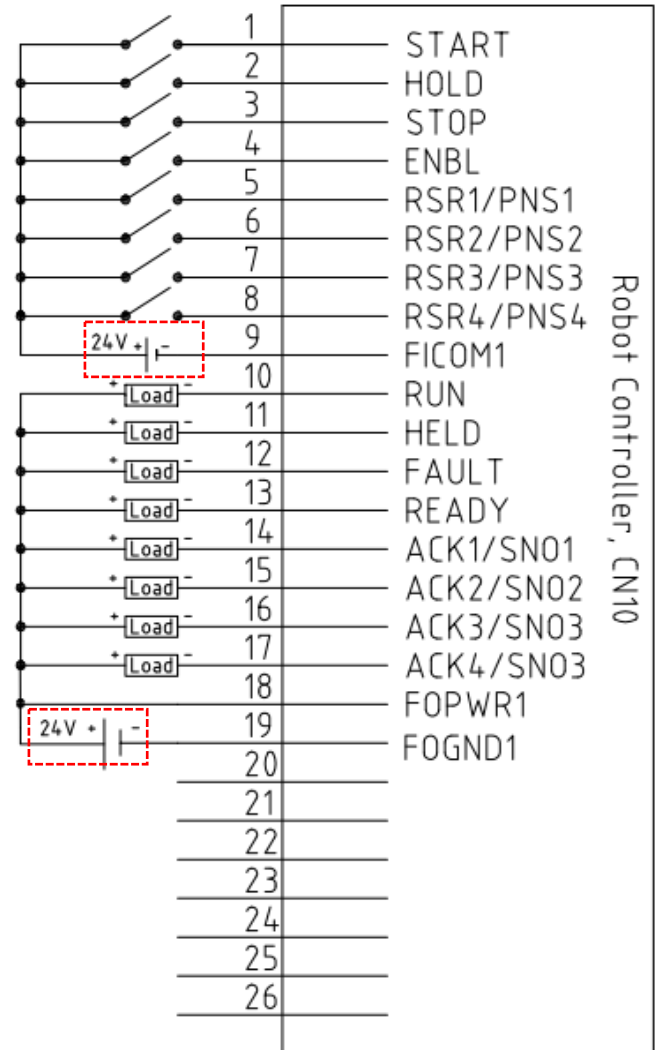
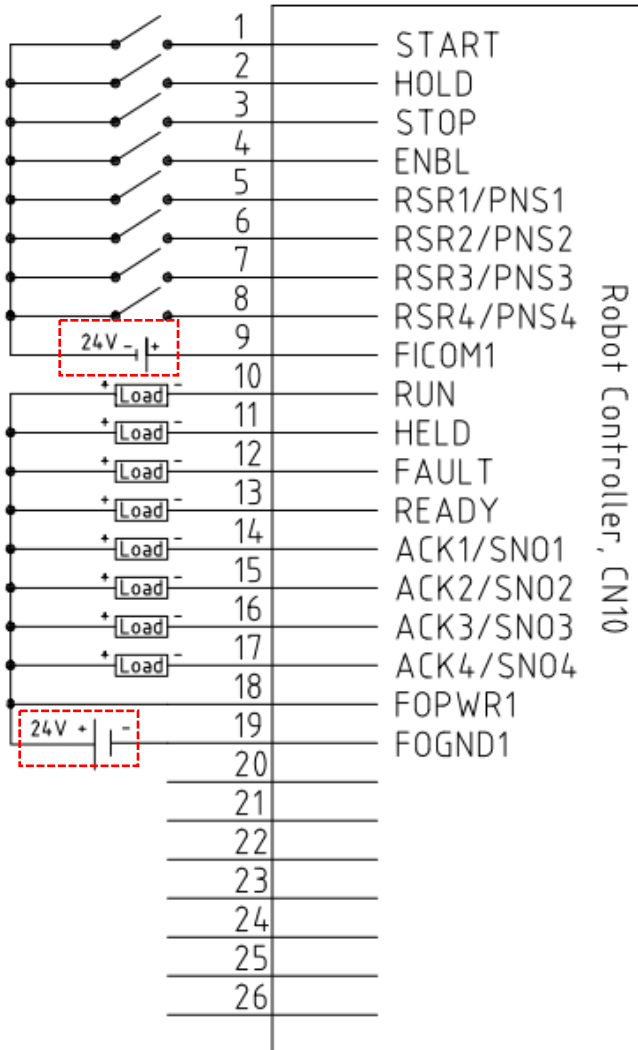

 <b>CAUTION</b>	<ul style="list-style-type: none"> <li>❖ The maximum current at the single output supplied by external output is 100mA.</li> <li>❖ The minimum current to trigger the external input is 10mA.</li> </ul>
---	--

### 3.2 Digital I/O

**Description:**

1. Standard equipment has Digital I/O of 16IN/16OUT, which are distributed in the CN5-I1 (D-SUB 26P) and CN5-O1 (D-SUB 26P) connectors.
2. Connection cable and terminal block for function I/O is an optional equipment (as shown on the picture on the right side). One set can connect 16 point. Two sets are needed to connect all Digital I/O.



**Digital I/O List**

CN5 I1

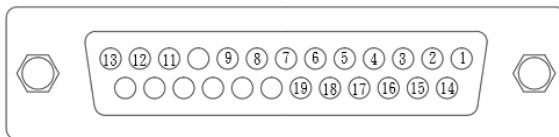

CN5 O1

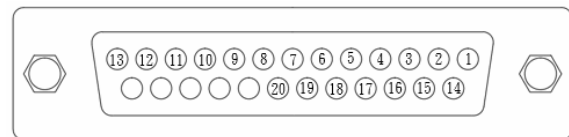

Input			
Pin	Parameter	Pin	Parameter
1	DI[1]	11	DI[9]
2	DI[2]	12	DI[10]
3	DI[3]	13	DI[11]
4	DI[4]	14	DI[12]
5	DI[5]	15	DI[13]
6	DI[6]	16	DI[14]
7	DI[7]	17	DI[15]
8	DI[8]	18	DI[16]
9	DICOM1 (Note 1)	19	DICOM2 (Note 1)

Output			
Pin	Parameter	Pin	Parameter
1	DO[1]	11	DO[9]
2	DO[2]	12	DO[10]
3	DO[3]	13	DO[11]
4	DO[4]	14	DO[12]
5	DO[5]	15	DO[13]
6	DO[6]	16	DO[14]
7	DO[7]	17	DO[15]
8	DO[8]	18	DO[16]
9	DOGND1 (Note2)	19	DOPWR2 (Note 2)
10	DOPWR1 (Note 2)	20	DOGND2 (Note 2)

\*Note1: DICOM1 is the common terminal for DI[1]-DI[8]; DICOM2 is the common terminal for DI[9]-DI[16].

\* Note 2: DOPWR1 and DOGND1 are power source of DO[1]~DO[8]. They should be connected to an external power supply.; DOPWR2 and DOGND2 are power source of DO[9]~DO[16]. They should be connected to an external power supply.

## Digital Input (CN5 I1) wiring diagram

The following figure shows the recommended wiring diagram for Digital input (CN5 I1)

 : External power supply

Input: NPN

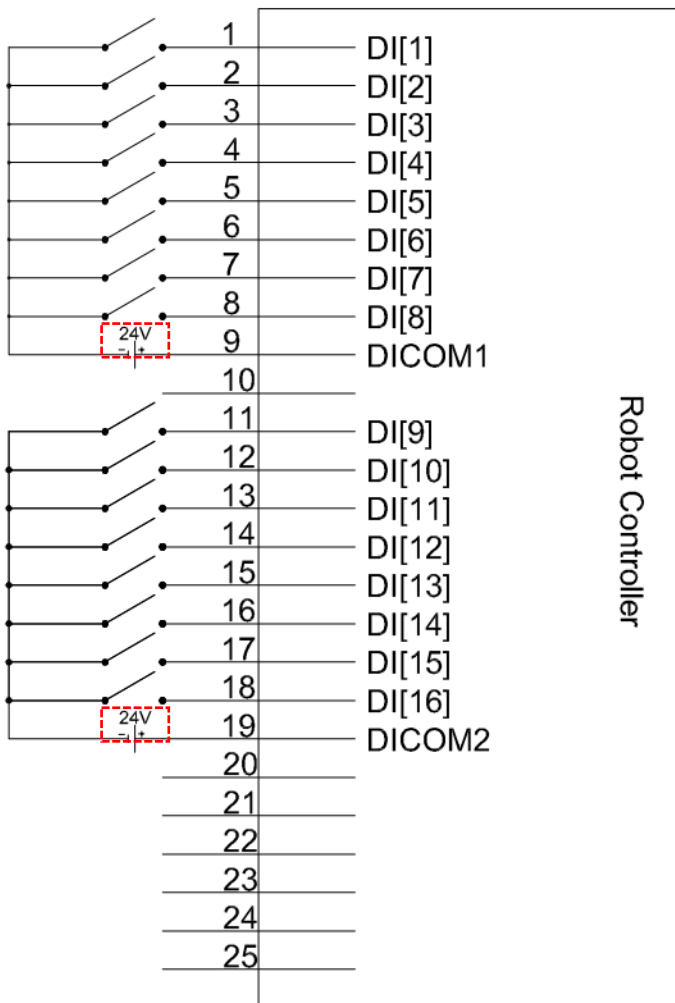

Input: PNP

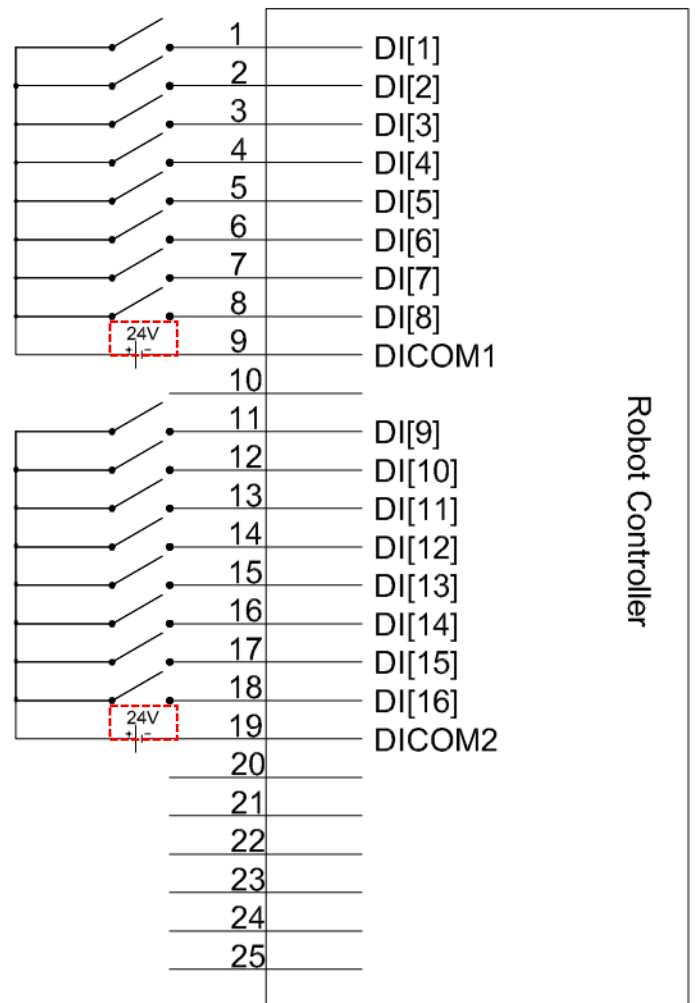

**CAUTION**

- ❖ The minimum current to trigger the external input is 10mA.

## Digital Output (CN5 O1) wiring diagram

The following figure shows the recommended wiring diagram for Digital Output (CN5 O1)

 : External power supply

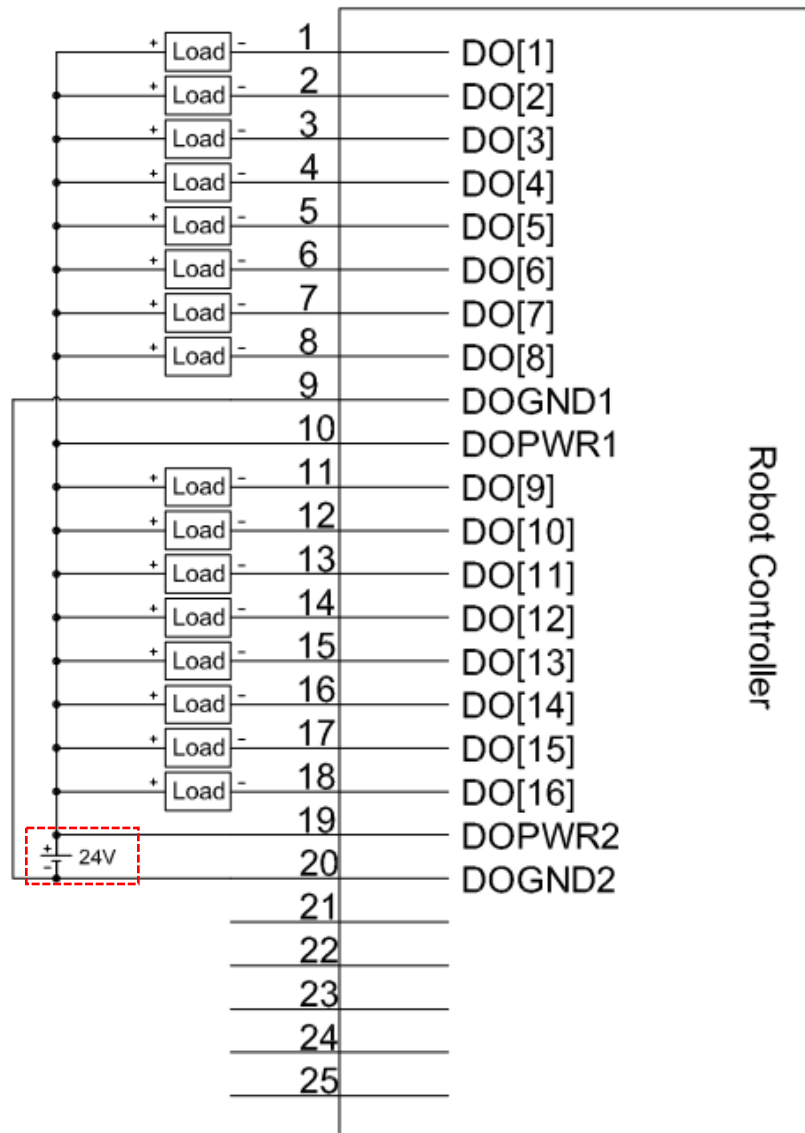



Note: Digital output only support NPN Type

 <b>CAUTION</b>	<p>❖ The maximum current at the single output supplied by external output is 100mA.</p>
---	---

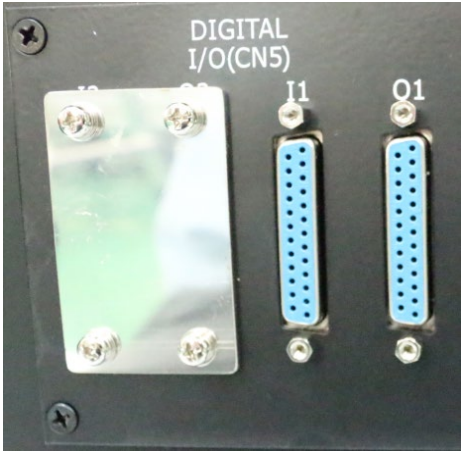
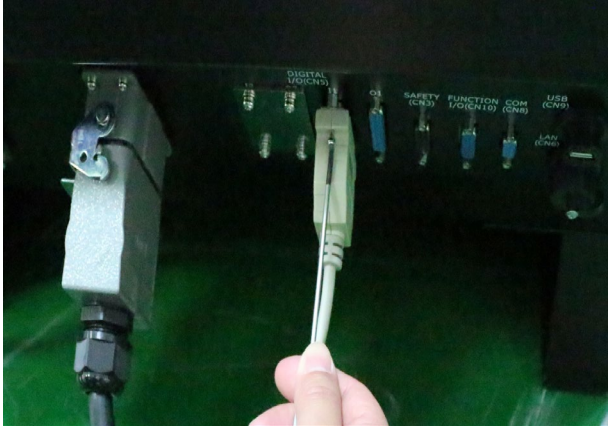
**Connection method:**

<p>The connector of Digital I/O on controller is CN5 which is designed fool-proofing. If it cannot be plugged in, please flip and connect it again. Please remove protection cover before connection.</p>	
<p>Plug the connector into CN5 and secure the screws indeed.</p>	

 <b>DANGER</b>	<ul style="list-style-type: none"> <li>❖ Any signal or power source should not be in close contact or in contact with any metal enclosure. Improper use may result in serious injury or loss of life or property.</li> </ul>
 <b>WARNING</b>	<ul style="list-style-type: none"> <li>❖ To prevent the internal component from damage, any wiring operation must be done only when the controller is off.</li> </ul>
 <b>CAUTION</b>	<ul style="list-style-type: none"> <li>❖ Please make sure the screws on the connector are secured.</li> </ul>

### 3.3 Digital I/O Expansion Module (Optional)

### Digital I/O List

Expansion digital I/O consist 16 points shown in the table below.

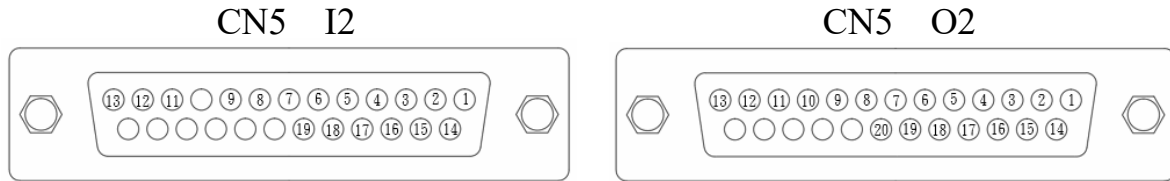

Input			
Pin	Parameter	Pin	Parameter
1	DI[17]	11	DI[25]
2	DI[18]	12	DI[26]
3	DI[19]	13	DI[27]
4	DI[20]	14	DI[28]
5	DI[21]	15	DI[29]
6	DI[22]	16	DI[30]
7	DI[23]	17	DI[31]
8	DI[24]	18	DI[32]
9	DICOM3 <sup>(Note 1)</sup>	19	DICOM4 <sup>(Note 1)</sup>

Output			
Pin	Parameter	Pin	Parameter
1	DO[17]	11	DO[25]
2	DO[18]	12	DO[26]
3	DO[19]	13	DO[27]
4	DO[20]	14	DO[28]
5	DO[21]	15	DO[29]
6	DO[22]	16	DO[30]
7	DO[23]	17	DO[31]
8	DO[24]	18	DO[32]
9	DOGND3 <sup>(Note2)</sup>	19	DOPWR4 <sup>(Note 2)</sup>
10	DOPWR3 <sup>(Note 2)</sup>	20	DOGND4 <sup>(Note 2)</sup>

\*Note1: DICOM3 is the common terminal for DI[17]-DI[24]; DICOM4 is the common terminal for DI[25]-DI[32].

\* Note 2: DOPWR3 and DOGND3 are power source of DO[17]~DO[24]. They should be connected to an external power supply.; DOPWR4 and DOGND4 are power source of DO[25]~DO[32]. They should be connected to an external power supply. The output is in NPN type.

 <b>CAUTION</b>	<ul style="list-style-type: none"> <li>❖ The maximum current at the single output supplied by external output is 100mA.</li> <li>❖ The minimum current to trigger the external input is 10mA.</li> </ul>
--------------------	--

### Digital Input (CN5 I1) wiring diagram



The following figure shows the recommended wiring diagram for Digital input (CN5 I2)

 : External power supply

Input: NPN

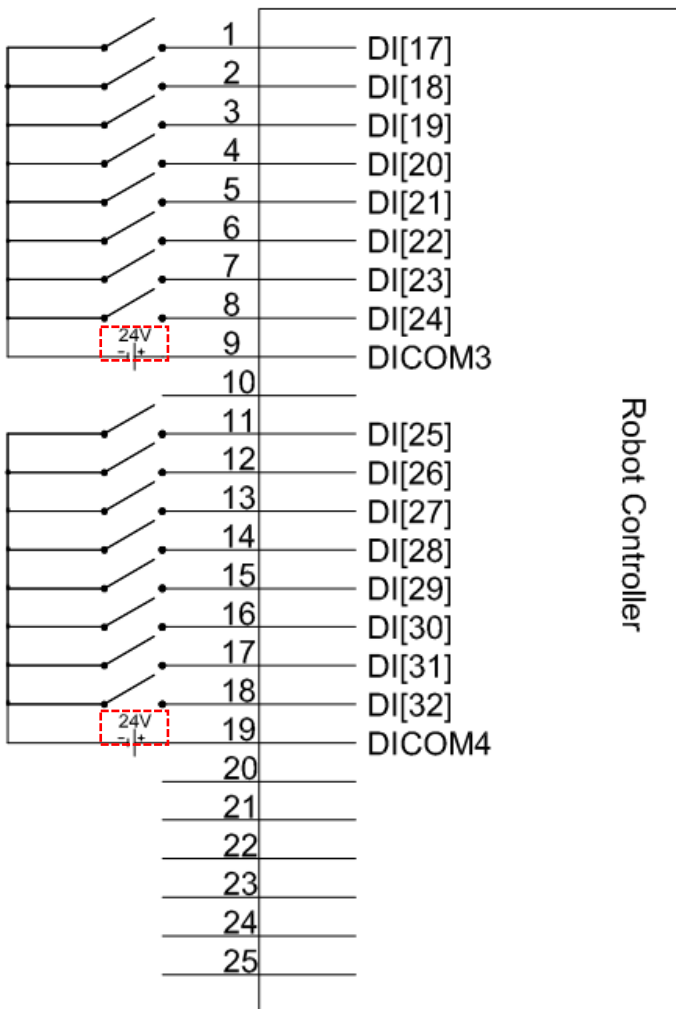

Input: PNP

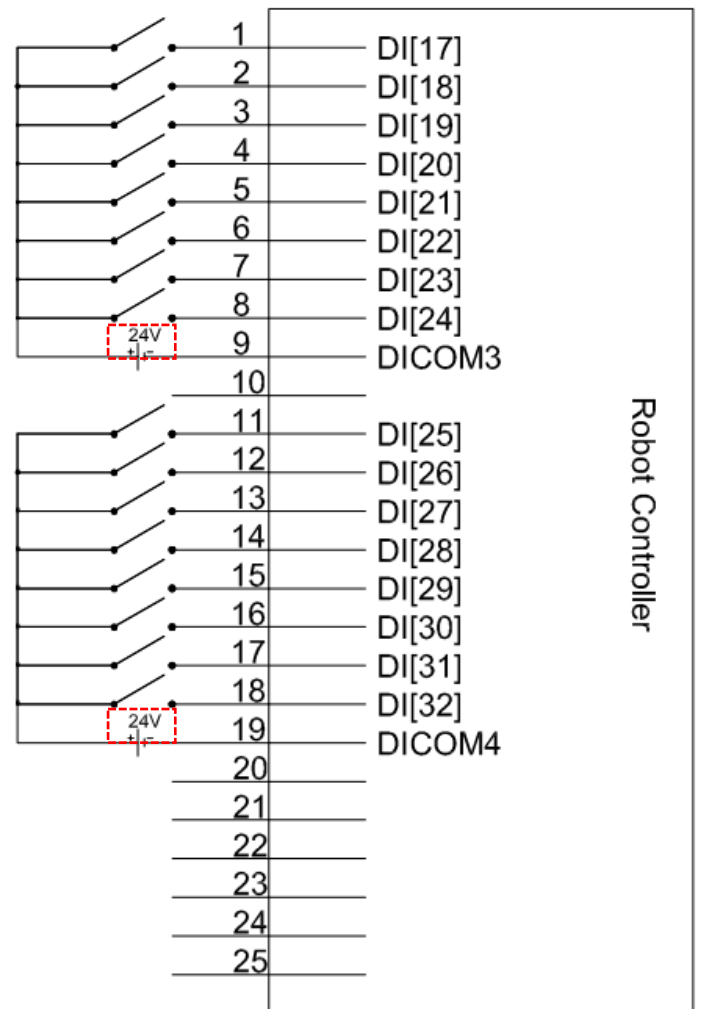

 <b>CAUTION</b>	<p>❖ The minimum current to trigger the external input is 10mA.</p>
---	---

**Digital Output (CN5 O2) wiring diagram**

The following figure shows the recommended wiring diagram for Digital Output (CN5 O2)

 : External power supply

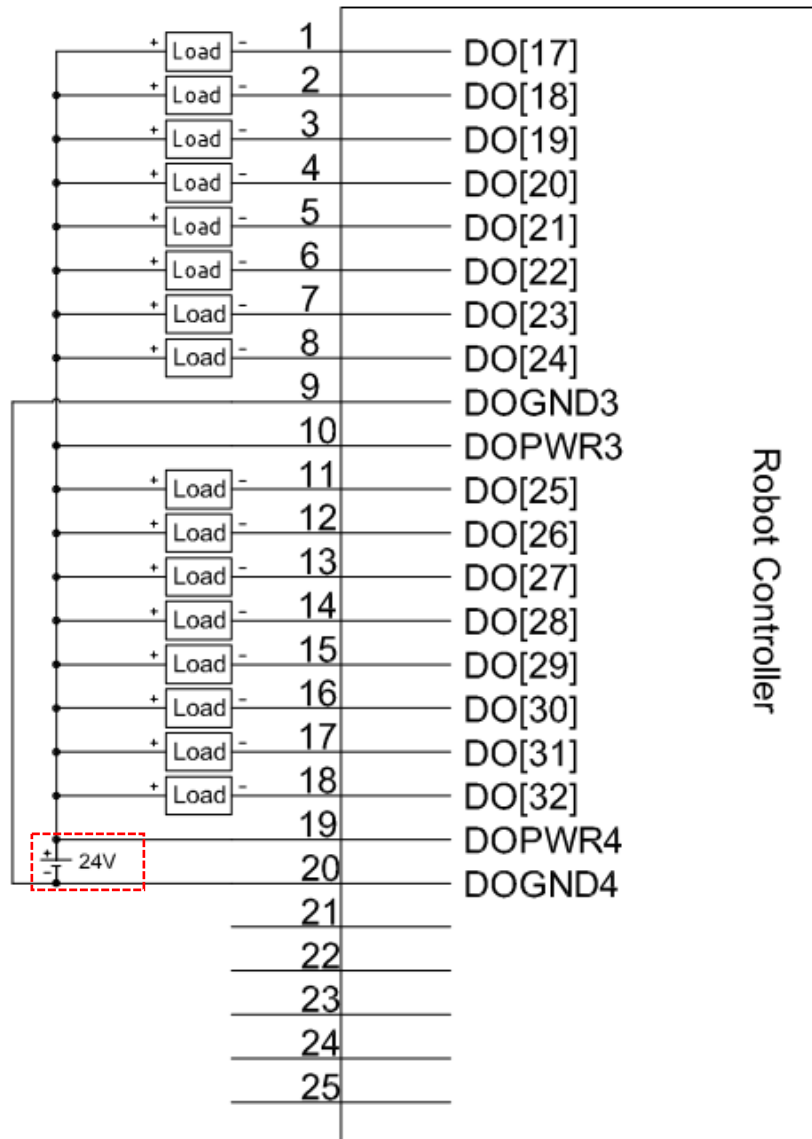

Note: Digital output only support NPN Type

 <b>CAUTION</b>	<p>❖ The maximum current at the single output supplied by external output is 100mA.</p>
---	---

### 3.4 Network Connection Port

**Description:**

When connecting to the internet port, it is recommended to use a wire shielded mesh route the network cable can be attached with a magnetic ring.

Remarks: The magnetic ring can be selected from the model (74271132, wurth elektronik) or same specification.

## 4. Teach Pendant

### Description:

The Teach Pendant provides the program edit, program management and motion position teaching etc. In addition, for user's safety, the Teach Pendant is equipped with the Emergency Stop Switch and the Enable Switch

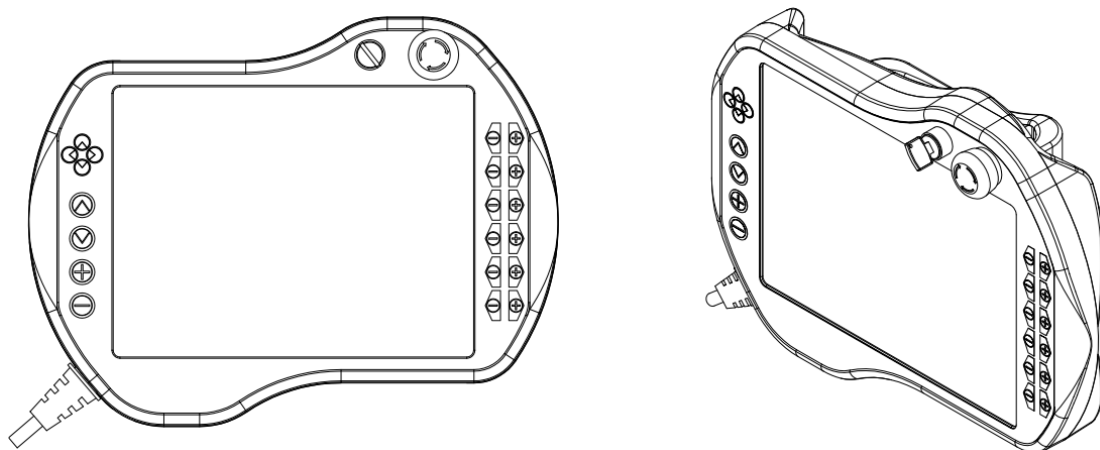

### Teach Pendant Specification:

Item	HIWIN Robot Teach Pendant
Model No.	TP02
Dimensions	318x245x107 mm <sup>3</sup>
Weight	2.5kg
Protection Rating	IP20
Display	10.2" touch screen
Resolution	1024x768 pixels
Mode	Manual, Auto and Lock
Physical Button	20keys + Enable Switch + Emergency Stop Switch + Key Switch
Cable Length	5m

 <b>WARNING</b>	<ul style="list-style-type: none"> <li>❖ It is forbidden to use Teach Pendant in the high dust concentration and high grease concentration surrounding since its protection rating is IP20.</li> <li>❖ To ensure the Teach Pendant functions normally, any impact and fall are forbidden.</li> </ul>
---	--

### Names and functions on Teach Pendant

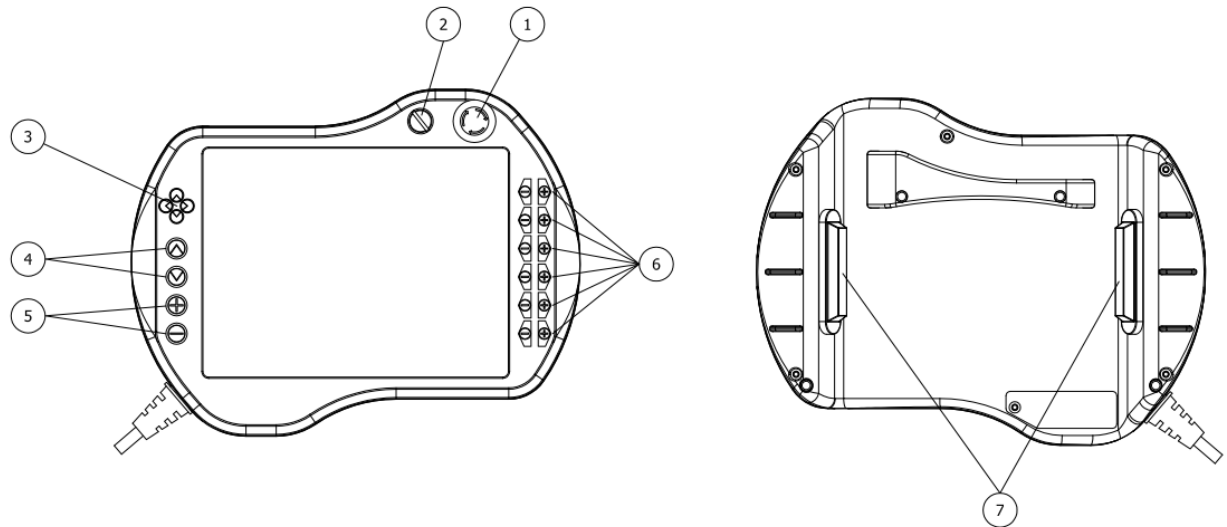

#### Button Definition:

No.	Item	Function
1	Emergency Stop Switch	Disable servo and directly stop the robot.
2	Mode Switch	Switch mode among Manu, Auto and Lock
3	XY-Axis T1 Key	In the T1 mode, move in XY-plane.
4	Z-Axis T1 Key	In the T1 mode, move in Z-axis.
5	Speed Key	Adjust the robot speed
6	T1Key	Adjust the value in each axis in the different mode.
7	Enable Switch <sup>(note 1)</sup>	When pressing one of the switches, the robot can move; the robot must directly stop when releasing this switch or pressing it to the end.

\*note 1: instruction on enable switch:

In T1 and T2 mode, the enable switch must be held at center position to start the robot. In Auto mode (AUT) and External Auto mode (EXT), the enable switch should be held at center position only in the moment it starts, and then release.

The Enable Switch has three positions:

- (1) Not pressed → The robot can't move.
- (2) Center position → The robot can move and teach
- (3) Fully pressed → The robot can't move.

In addition, the enable switch on both side has the same function.

## 5. Maintenance

### 5.1 UPS Battery (Only For Non-CE Version)

The controller contains a battery, the battery is charged as:

- (1) When first time power-on, the battery needs to be charged greater than 4HR.  
(Manipulator can be performed simultaneously)
- (2) When it is in a low battery state (the UPS will produce around 2~3 beep sound for 1 second), the controller should be switched on more than 4HR for charging UPS.
- (3) If the controller is idle for more than one month, please charge it more than 4HR

When the voltage of UPS is too low (lower than 10.2V) or due to malfunction causing the controller unable to reboot, please replace the battery. (Refer to CH1.3 standard and optional equipment)

Note 1: If battery failed during warranty period, free replacement of battery will be provided.

Note 2: Starting from 15<sup>th</sup> month once the controller is started using, the battery voltage should be measured every month using multimeter in order to make sure the battery quality, if voltage lower than 10.2V, please replace the battery. Measured point is shown below.

Procedure for replacing UPS battery is shown as follows:

- (1) Switch off the controller power and open the cover.
- (2) The battery is located on the left side in the cabinet. Remove the metal plate and the power cable connected to the battery, then take out the battery.
- (3) When battery is replaced, reconnect the power cable to the battery ,make sure it is firmly secured.
- (4) After ensuring the battery is fixed, connect it with the power cable. Install the cover in order, after confirming that all the cables are connected securely.

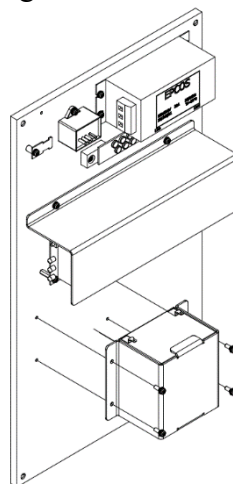



**CAUTION**

- ❖ After replacement, please ensure the polarities of battery and power cable are connected correctly; positive (red) to positive and negative (black) to negative.
- ❖ The controller contains lead-acid battery. It may cause the lack of electricity by natural wearing and will not be able to be turned on successfully. If it is idle for a long time, please maintain the power transmission at least every 3 months and keep it on lasting for 24 hours. Or take out the battery and keep the voltage of the battery over 13V.
- ❖ When the voltage of the battery is too low causing failure to turn on the controller, please take out the battery and charge it with the external power source until the voltage is over 13V. Or replace the battery with a new one and then try to turn it on again.
- ❖ Flipping it 90 degrees on the side or turning it over 180 degrees are forbidden while installing the controller. This is to protect the internal battery component.

## **Articulated Robot Controller-RCA620** (Original Instruction) **User Manual**

Publication Date : September 2018, first edition

- 
1. HIWIN is the registered trademark of HIWIN Technologies Corp.. For your protection; To avoid counterfeit products, be certain you are buying genuine HIWIN products before purchase.
  2. Actual products may be different from the specifications and photos in this catalog. The differences in appearances or specifications may be caused by, among other things, product improvements.
  3. HIWIN will not sell or export those techniques and products restricted under the "Foreign Trade Act" and relevant regulations. Any export of restricted products should be approved by competent authorities in accordance with relevant laws, and shall not be used to manufacture or develop nuclear, biochemical, missile and other military weapons.
  4. HIWIN website for patented product directory: [http://www.hiwin.tw/Products/Products\\_patents.aspx](http://www.hiwin.tw/Products/Products_patents.aspx)





## Subsidiaries / Research Center

HIWIN GmbH  
OFFENBURG, GERMANY  
[www.hiwin.de](http://www.hiwin.de)  
[www.hiwin.eu](http://www.hiwin.eu)  
[info@hiwin.de](mailto:info@hiwin.de)

HIWIN JAPAN  
KOBE · TOKYO · NAGOYA · NAGANO ·  
TOHOKU · SHIZUOKA · HOKURIKU ·  
HIROSHIMA · FUKUOKA · KUMAMOTO,  
JAPAN  
[www.hiwin.co.jp](http://www.hiwin.co.jp)  
[info@hiwin.co.jp](mailto:info@hiwin.co.jp)

HIWIN USA  
CHICAGO · SILICON VALLEY, U.S.A.  
[www.hiwin.com](http://www.hiwin.com)  
[info@hiwin.com](mailto:info@hiwin.com)

HIWIN Srl  
BRUGHERIO, ITALY  
[www.hiwin.it](http://www.hiwin.it)  
[info@hiwin.it](mailto:info@hiwin.it)

HIWIN Schweiz GmbH  
JONA, SWITZERLAND  
[www.hiwin.ch](http://www.hiwin.ch)  
[info@hiwin.ch](mailto:info@hiwin.ch)

HIWIN s.r.o.  
BRNO, CZECH REPUBLIC  
[www.hiwin.cz](http://www.hiwin.cz)  
[info@hiwin.cz](mailto:info@hiwin.cz)

HIWIN SINGAPORE  
SINGAPORE  
[www.hiwin.sg](http://www.hiwin.sg)  
[info@hiwin.sg](mailto:info@hiwin.sg)

HIWIN KOREA  
SUWON · MASAN, KOREA  
[www.hiwin.kr](http://www.hiwin.kr)  
[info@hiwin.kr](mailto:info@hiwin.kr)

HIWIN CHINA  
SUZHOU, CHINA  
[www.hiwin.cn](http://www.hiwin.cn)  
[info@hiwin.cn](mailto:info@hiwin.cn)

Mega-Fabs Motion System, Ltd.  
HAIFA, ISRAEL  
[www.mega-fabs.com](http://www.mega-fabs.com)  
[info@mega-fabs.com](mailto:info@mega-fabs.com)

## HIWIN TECHNOLOGIES CORP.

No. 7, Jingke Road,  
Taichung Precision Machinery Park,  
Taichung 40852, Taiwan  
Tel: +886-4-23594510  
Fax: +886-4-23594420  
[www.hiwin.tw](http://www.hiwin.tw)  
[business@hiwin.tw](mailto:business@hiwin.tw)